

CGH40006S

6 W, RF Power GaN HEMT, Plastic

Cree's CGH40006S is an unmatched, gallium nitride (GaN) high electron mobility transistor (HEMT). The CGH40006S, operating from a 28 volt rail, offers a general purpose, broadband solution to a variety of RF and microwave applications. GaN HEMTs offer high efficiency, high gain and wide bandwidth capabilities making the CGH40006S ideal for linear and compressed amplifier circuits. The transistor is available in a 3mm x 3mm, surface mount, quad-flat-no-lead (QFN) package.



Package Types: 440203
PN's: CGH40006S

FEATURES

- Up to 6 GHz Operation
- 13 dB Small Signal Gain at 2.0 GHz
- 11 dB Small Signal Gain at 6.0 GHz
- 8 W typical at $P_{IN} = 32$ dBm
- 65 % Efficiency at $P_{IN} = 32$ dBm
- 28 V Operation
- 3mm x 3mm Package

APPLICATIONS

- 2-Way Private Radio
- Broadband Amplifiers
- Cellular Infrastructure
- Test Instrumentation
- Class A, AB, Linear amplifiers suitable for OFDM, W-CDMA, EDGE, CDMA waveforms

Absolute Maximum Ratings (not simultaneous) at 25°C Case Temperature

Parameter	Symbol	Rating	Units	Conditions
Drain-Source Voltage	V_{DS}	84	Volts	25°C
Gate-to-Source Voltage	V_{GS}	-10, +2	Volts	25°C
Storage Temperature	T_{STG}	-65, +150	°C	
Operating Junction Temperature	T_J	175	°C	
Maximum Forward Gate Current	I_{GMAX}	2.1	mA	25°C
Maximum Drain Current ¹	I_{DMAX}	0.75	A	25°C
Soldering Temperature ²	T_S	260	°C	
Thermal Resistance, Junction to Case ^{3,4}	$R_{\theta JC}$	10.1	°C/W	85°C
Case Operating Temperature ^{3,4}	T_C	-40, +150	°C	

Note:

¹ Current limit for long term, reliable operation

² Refer to the Application Note on soldering at www.cree.com/RF/Document-Library

³ Measured for the CGH40006S at $P_{DISS} = 8\text{ W}$.

⁴ T_C = Case temperature for the device. It refers to the temperature at the ground tab underneath the package. The PCB will add additional thermal resistance. The RTH for Cree's demonstration amplifier, CGH40006S-AMP1, with 13 (Ø20 mil) via holes designed on a 20 mil thick Rogers 5880 PCB, is 5.1°C. The total Rth from the heat sink to the junction is 10.1°C + 5.1°C = 15.2 °C/W.

Electrical Characteristics ($T_c = 25^\circ\text{C}$)

Characteristics	Symbol	Min.	Typ.	Max.	Units	Conditions
DC Characteristics¹						
Gate Threshold Voltage	$V_{GS(th)}$	-3.8	-3.0	-2.3	V_{DC}	$V_{DS} = 10\text{ V}, I_D = 2.1\text{ mA}$
Gate Quiescent Voltage	$V_{GS(Q)}$	-	-2.7	-	V_{DC}	$V_{DS} = 28\text{ V}, I_D = 100\text{ mA}$
Saturated Drain Current	I_{DS}	1.7	2.1	-	A	$V_{DS} = 6.0\text{ V}, V_{GS} = 2.0\text{ V}$
Drain-Source Breakdown Voltage	V_{BR}	120	-	-	V_{DC}	$V_{GS} = -8\text{ V}, I_D = 2.1\text{ mA}$
RF Characteristics² ($T_c = 25^\circ\text{C}$, $F_o = 5.8\text{ GHz}$ unless otherwise noted)						
Small Signal Gain	G_{SS}	10	11.8	-	dB	$V_{DD} = 28\text{ V}, I_{DQ} = 100\text{ mA}$
Power Output at $P_{IN} = 30\text{ dBm}$	P_{OUT}	5	6.9	-	W	$V_{DD} = 28\text{ V}, I_{DQ} = 100\text{ mA}$
Drain Efficiency ³	η	40	53	-	%	$V_{DD} = 28\text{ V}, I_{DQ} = 100\text{ mA}, P_{IN} = 30\text{ dBm}$
Output Mismatch Stress	VSWR	-	-	10 : 1	Ψ	No damage at all phase angles, $V_{DD} = 28\text{ V}, I_{DQ} = 100\text{ mA},$ $P_{IN} = 32\text{ dBm}$
Dynamic Characteristics						
Input Capacitance	C_{GS}	-	2.7	-	pF	$V_{DS} = 28\text{ V}, V_{gs} = -8\text{ V}, f = 1\text{ MHz}$
Output Capacitance	C_{DS}	-	0.8	-	pF	$V_{DS} = 28\text{ V}, V_{gs} = -8\text{ V}, f = 1\text{ MHz}$
Feedback Capacitance	C_{GD}	-	0.1	-	pF	$V_{DS} = 28\text{ V}, V_{gs} = -8\text{ V}, f = 1\text{ MHz}$

Notes:

¹ Measured on wafer prior to packaging.

² Measured in Cree's narrow band production test fixture AD-000291. This fixture is designed for high volume test at 5.8 GHz and may not show the full capability of the device due to source inductance and thermal performance. The demonstration amplifier, CGH40006S-AMP1, is a better indicator of the true RF performance of the device.

³ Drain Efficiency = P_{OUT} / P_{DC}

Typical Performance

Small Signal Gain vs Frequency at 28 V
of the CGH40006S in the CGH40006S-AMP1

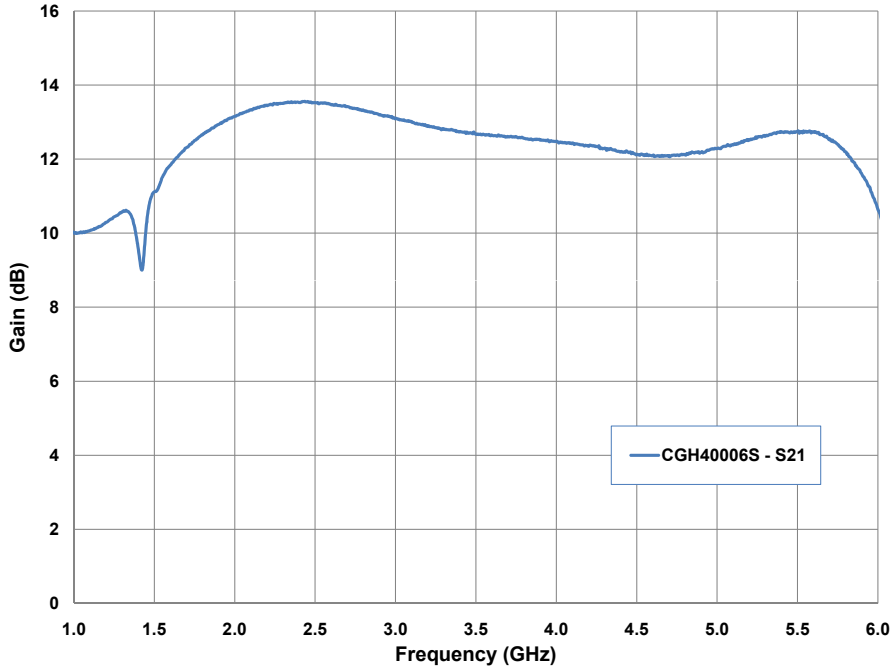

Input & Output Return Losses vs Frequency at
28 V of the CGH40006S in the CGH40006S-AMP1

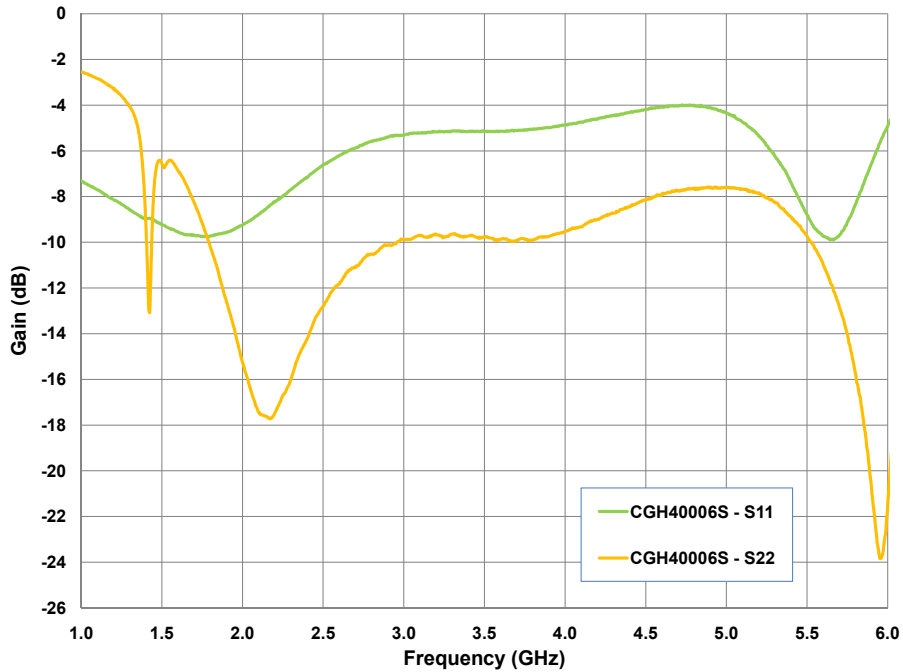

Typical Performance

**Power Gain vs Output Power as a Function of Frequency
of the CGH40006S in the CGH40006S-AMP1**
 $V_{DD} = 28\text{ V}, I_{DQ} = 100\text{ mA}$

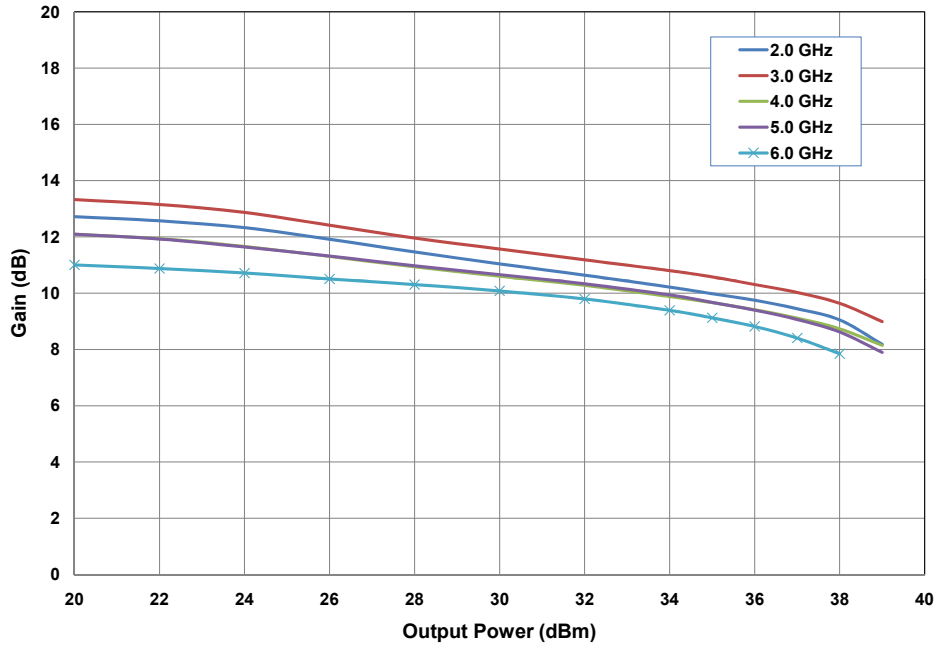

**Drain Efficiency vs Output Power as a Function of Frequency
of the CGH40006S in the CGH40006S-AMP1**
 $V_{DD} = 28\text{ V}, I_{DQ} = 100\text{ mA}$

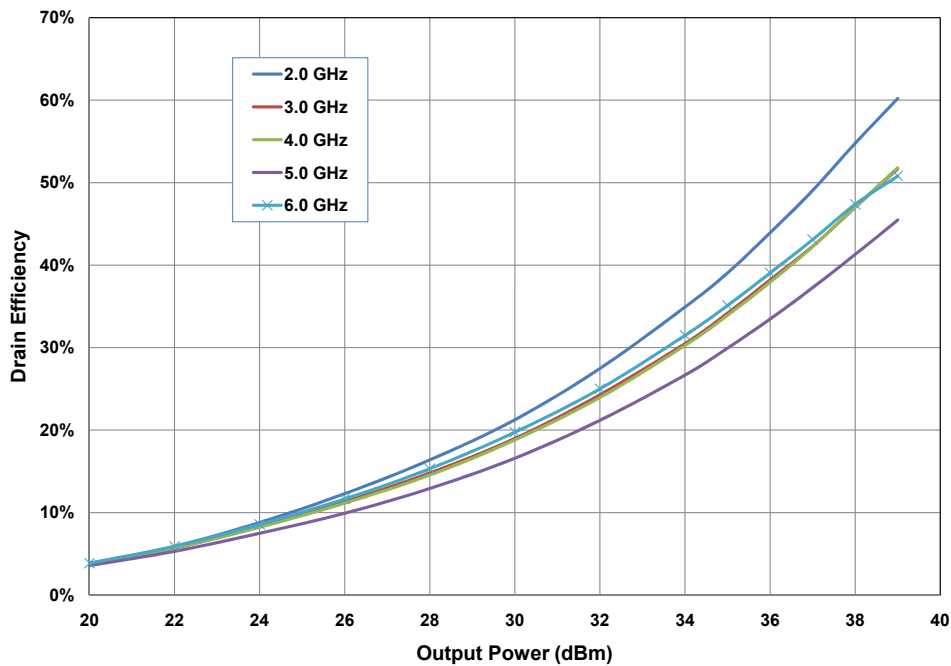

Typical Performance

**Power Gain vs Input Power as a Function of Frequency
of the CGH40006S in the CGH40006S-AMP1**
 $V_{DD} = 28\text{ V}, I_{DQ} = 100\text{ mA}$

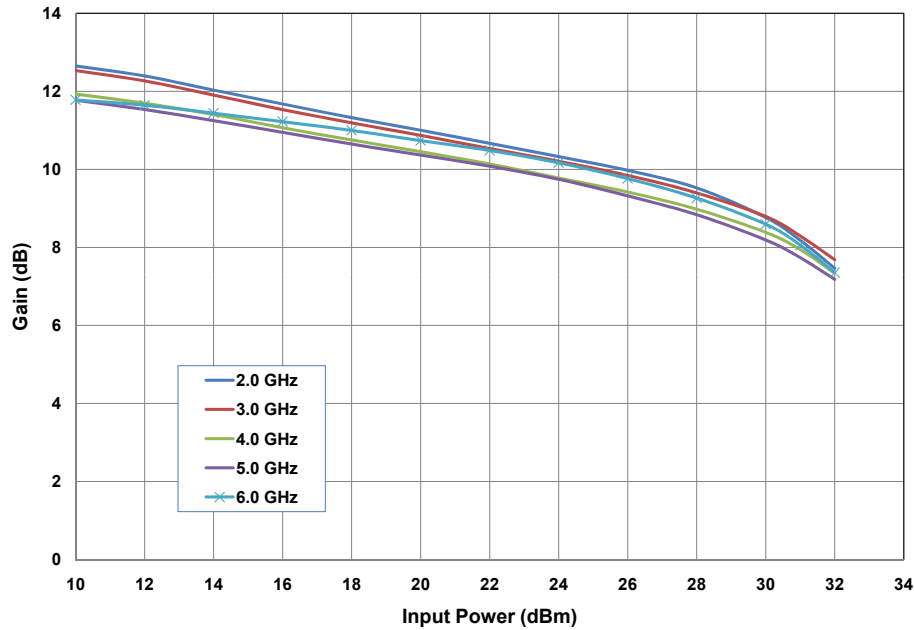

**Drain Efficiency vs Input Power as a Function of Frequency
of the CGH40006S in the CGH40006S-AMP1**
 $V_{DD} = 28\text{ V}, I_{DQ} = 100\text{ mA}$

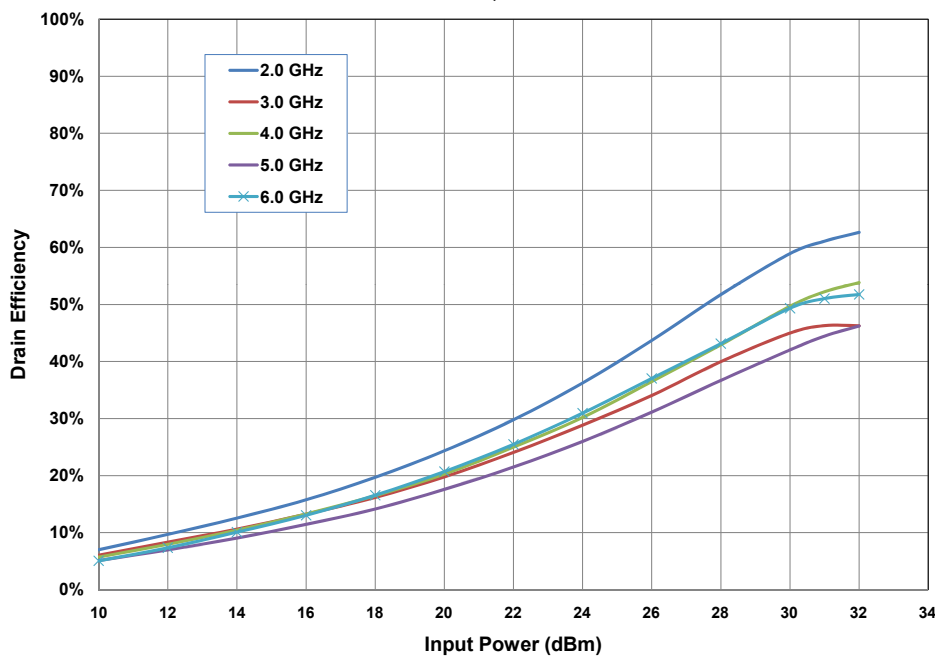

Typical Performance

**Power Gain vs Frequency of the CGH40006S
in the CGH40006S-AMP1 at $P_{IN} = 32$ dBm, $V_{DD} = 28$ V**

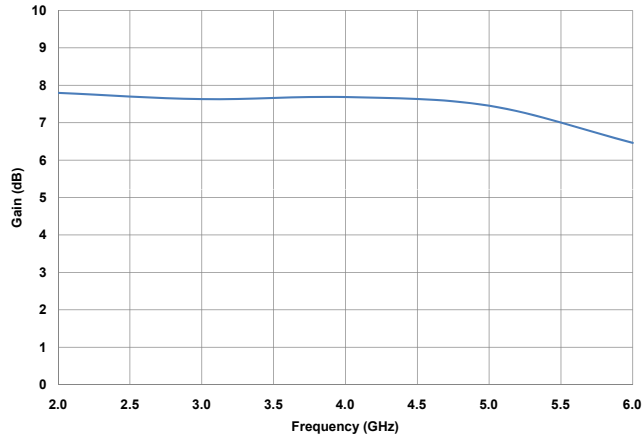

**Output Power vs Frequency of the CGH40006S
in the CGH40006S-AMP1 at $P_{IN} = 32$ dBm, $V_{DD} = 28$ V**

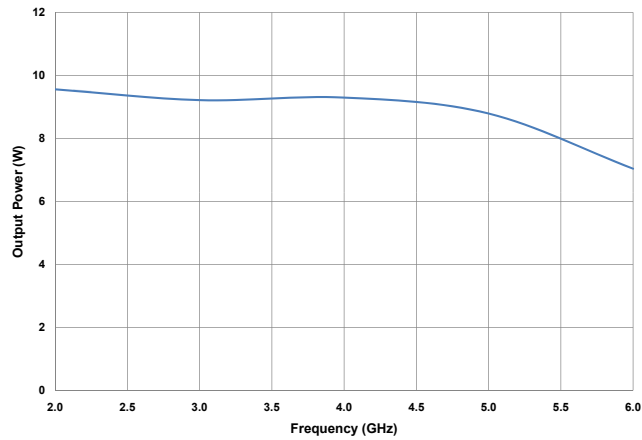

**Drain Efficiency vs Frequency of the CGH40006S
in the CGH40006S-AMP1 at $P_{IN} = 32$ dBm, $V_{DD} = 28$ V**

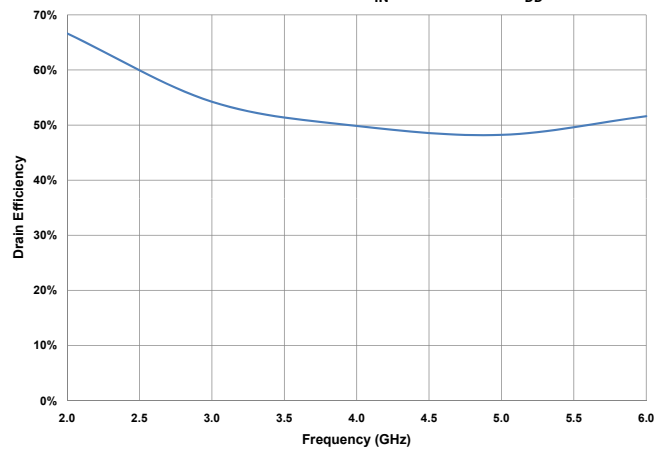

Typical Performance

**Third Order Intermodulation Distortion vs Average Output Power
as a Function of Frequency of the CGH40006S in the CGH40006S-AMP1**
 $V_{DD} = 28\text{ V}, I_{DQ} = 60\text{ mA}$

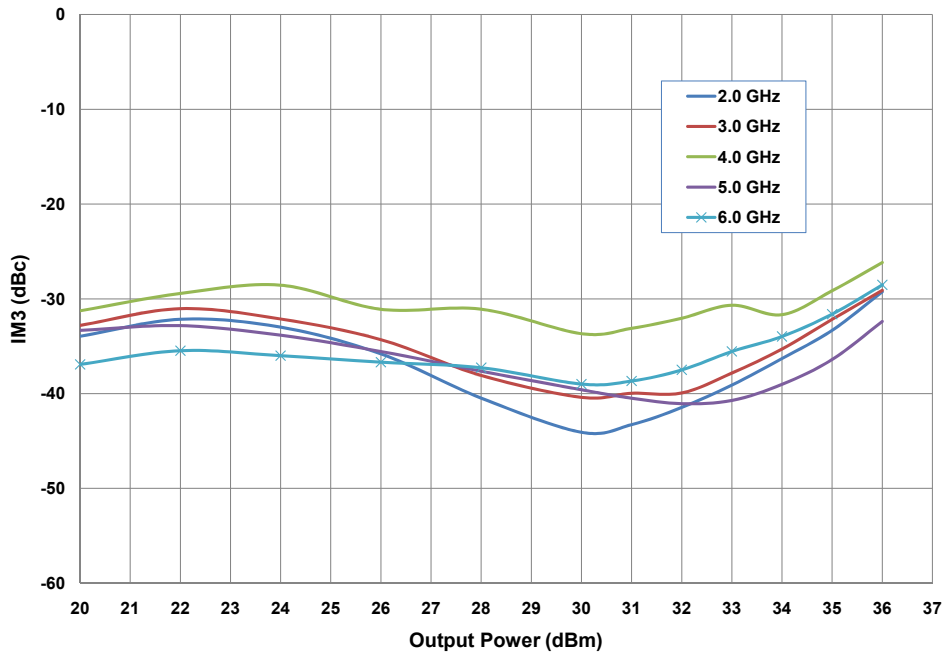

Electrostatic Discharge (ESD) Classifications

Parameter	Symbol	Class	Test Methodology
Human Body Model	HBM	1A (> 250 V)	JEDEC JESD22 A114-D
Charge Device Model	CDM	2 (125 V to 250 V)	JEDEC JESD22 C101-C

Moisture Sensitivity Level (MSL) Classification

Parameter	Symbol	Level	Test Methodology
Moisture Sensitivity Level	MSL	3 (168 hours)	IPC/JEDEC J-STD-20

Typical Performance

Simulated Maximum Available Gain and K Factor of the CGH40006S

$V_{DD} = 28\text{ V}$, $I_{DQ} = 100\text{ mA}$

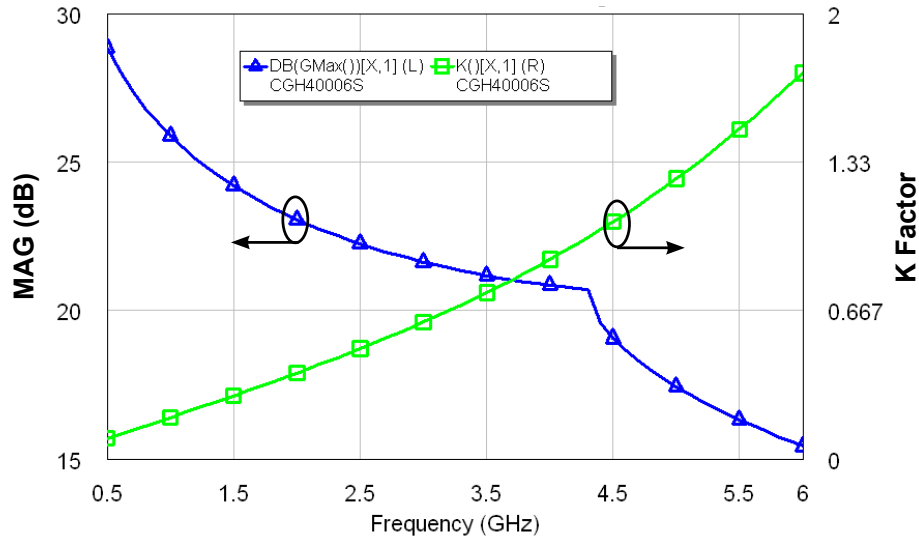

Note 1. On a 20 mil thick PCB.

Typical Noise Performance

Simulated Minimum Noise Figure and Noise Resistance vs Frequency of the CGH40006S

$V_{DD} = 28\text{ V}$, $I_{DQ} = 100\text{ mA}$

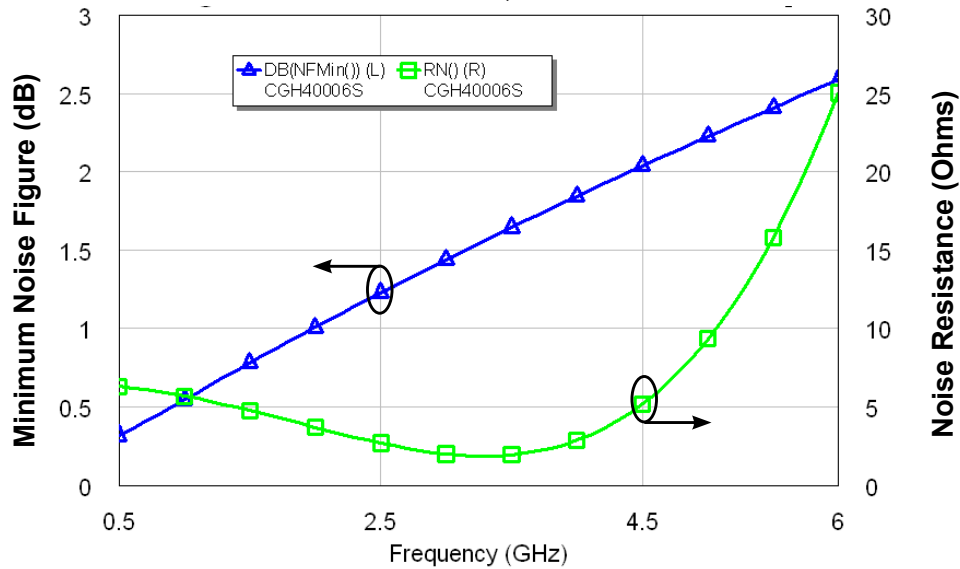

Note 1. On a 20 mil thick PCB.

CGH40006S CW Power Dissipation De-rating Curve

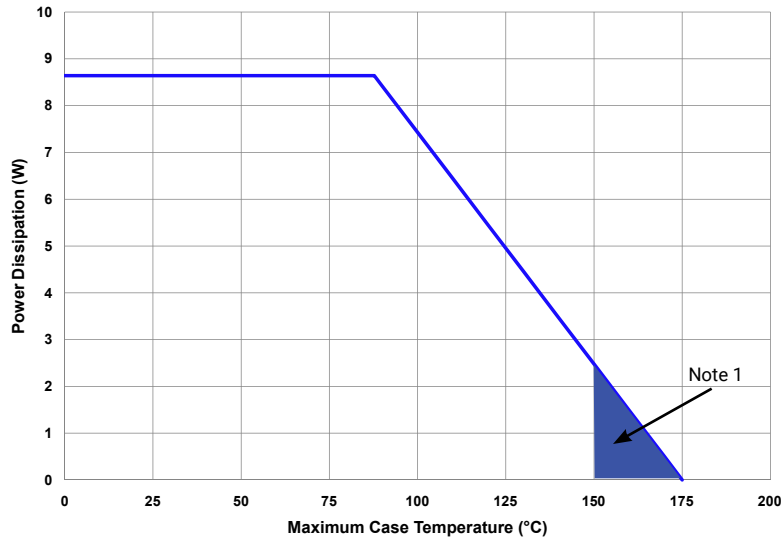

Note 1. Area exceeds Maximum Case Operating Temperature (See Page 2).

Source and Load Impedances

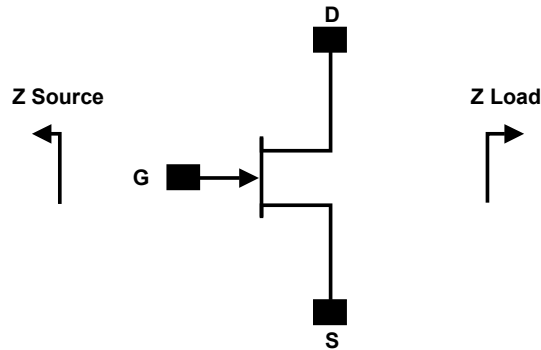

Frequency (MHz)	Z Source	Z Load
1000	12.7 + j20.2	62.3 + j42
2000	5.98 + j6.81	32.7 + j32.9
3000	3.32 - j2.89	19.2 + j29.8
4000	2.38 - j9.45	15.2 + j15.7
5000	2.62 - j15.6	9.98 + j9.6
6000	1.94 - j21.35	8.51 + j2.07

Note 1. $V_{DD} = 28V$, $I_{DQ} = 100mA$ in the 440203 package.

Note 2. Optimized for power gain, P_{SAT} and PAE.

Note 3. When using this device at low frequency, series resistors should be used to maintain amplifier stability.

Note 4. 35 pF source inductance is assumed between the package and RF ground (20 mil thick PCB).

CGH40006S-AMP1 Demonstration Amplifier Circuit Bill of Materials

Designator	Description	Qty
R1	RES, AIN, 0505, 470 Ohms ($\leq 5\%$ tolerance)	1
R2	RES, AIN, 0505, 50 Ohms ($\leq 5\%$ tolerance)	1
R3	RES, AIN, 0505, 360 Ohms ($\leq 5\%$ tolerance)	1
C1	CAP, 1.3 pF +/-0.1 pF, 0603, ATC 600S	1
C2	CAP, 2.7 pF +/-0.25 pF, 0603, ATC 600S	1
C10	CAP, 3.6 pF +/-0.1 pF, 0603, ATC 600S	1
C4,C11	CAP, 8.2 pF +/-0.25, 0603, ATC 600S	2
C6,C13	CAP, 470 pF +/-5%, 0603, 100 V	2
C7,C14	CAP, 33000 pF, CER, 100V, X7R, 0805	2
C8	CAP, 10 uF, 16V, SMT, TANTALUM	1
C15	CAP, 1.0 uF +/-10%, CER, 100V, X7R, 1210	1
C16	CAP, 33 uF, 100V, ELECT, FK, SMD	1
J3,J4	CONN, SMA, STR, PANEL, JACK, RECP	2
J1	HEADER RT>PLZ .1CEN LK 5POS	1
-	PCB, RO5880, 0.020" THK	1
Q1	CGH40006S	1

CGH40006S-AMP1 Demonstration Amplifier Circuit

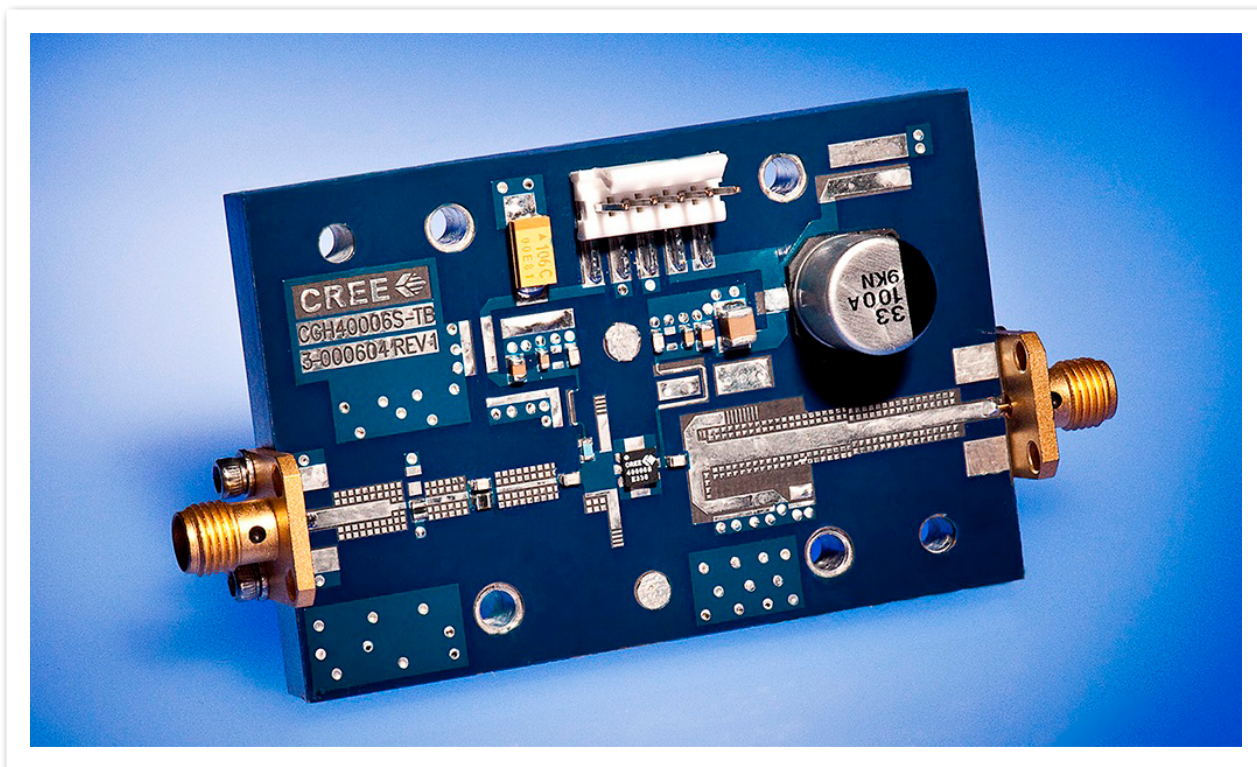

CGH40006S-AMP1 Demonstration Amplifier Circuit Schematic

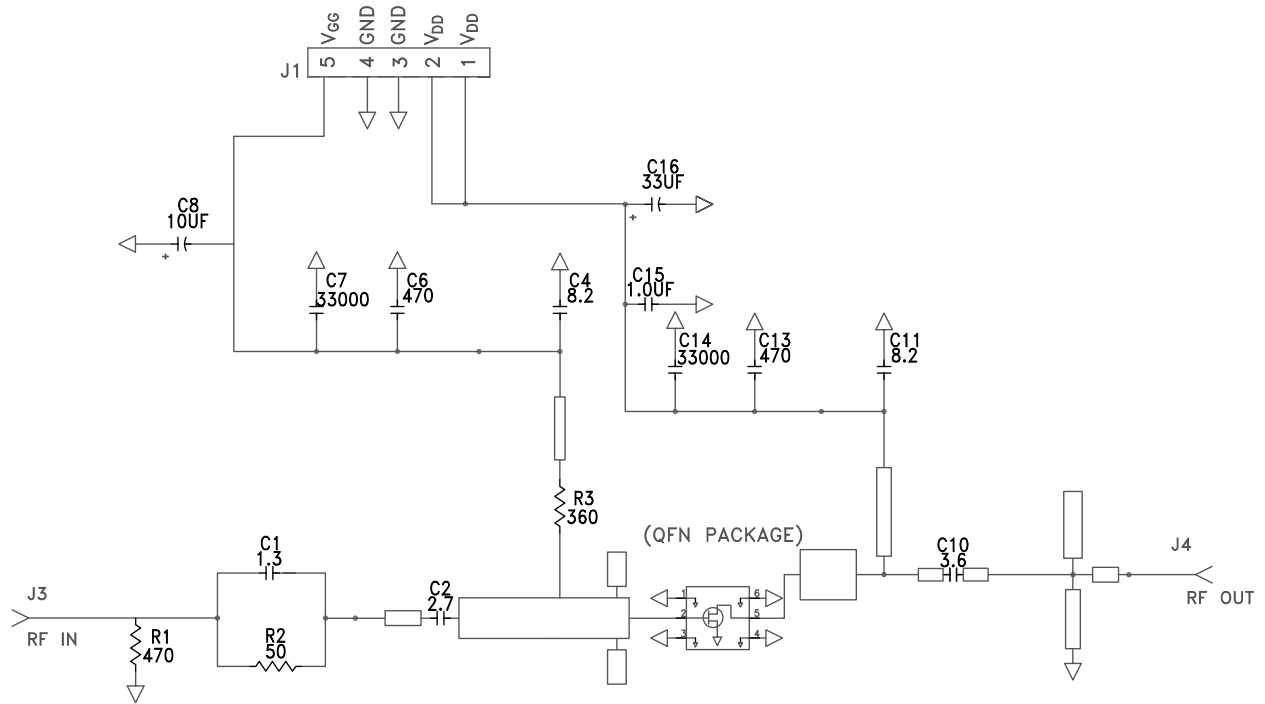

CGH40006S-AMP1 Demonstration Amplifier Circuit Outline

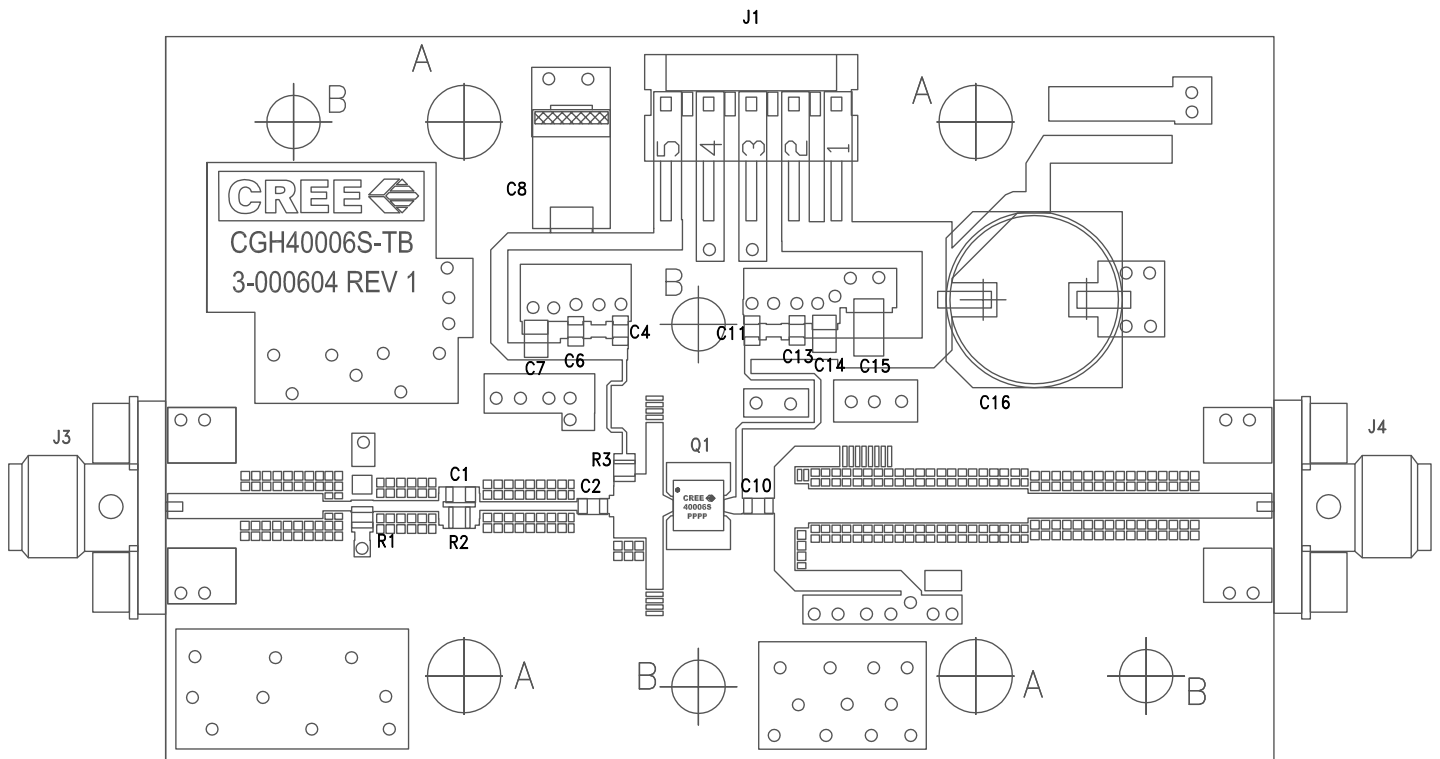

Typical Package S-Parameters for CGH40006S
 (Small Signal, $V_{DS} = 28\text{ V}$, $I_{DQ} = 100\text{ mA}$, angle in degrees)

Frequency	Mag S11	Ang S11	Mag S21	Ang S21	Mag S12	Ang S12	Mag S22	Ang S22
500 MHz	0.933	-92.95	18.74	125.47	0.024	38.02	0.459	-48.87
600 MHz	0.922	-104.26	16.89	118.64	0.026	31.70	0.428	-54.78
700 MHz	0.912	-113.77	15.28	112.75	0.028	26.33	0.402	-59.82
800 MHz	0.905	-121.83	13.90	107.61	0.029	21.71	0.381	-64.21
900 MHz	0.899	-128.73	12.70	103.06	0.030	17.68	0.365	-68.10
1.0 GHz	0.894	-134.72	11.67	98.96	0.030	14.11	0.352	-71.62
1.1 GHz	0.891	-139.97	10.77	95.23	0.030	10.91	0.342	-74.86
1.2 GHz	0.888	-144.62	9.99	91.80	0.031	8.00	0.334	-77.87
1.3 GHz	0.886	-148.78	9.31	88.61	0.031	5.34	0.328	-80.72
1.4 GHz	0.884	-152.55	8.71	85.61	0.031	2.88	0.325	-83.43
1.5 GHz	0.883	-155.97	8.17	82.77	0.031	0.58	0.322	-86.03
1.6 GHz	0.881	-159.12	7.69	80.07	0.031	-1.57	0.321	-88.54
1.7 GHz	0.881	-162.04	7.26	77.49	0.031	-3.60	0.321	-90.98
1.8 GHz	0.880	-164.75	6.88	75.00	0.031	-5.53	0.321	-93.35
1.9 GHz	0.879	-167.29	6.53	72.60	0.031	-7.38	0.323	-95.67
2.0 GHz	0.879	-169.68	6.21	70.26	0.031	-9.14	0.325	-97.94
2.1 GHz	0.879	-171.94	5.92	68.00	0.030	-10.83	0.327	-100.17
2.2 GHz	0.879	-174.09	5.65	65.79	0.030	-12.46	0.330	-102.36
2.3 GHz	0.879	-176.14	5.40	63.62	0.030	-14.03	0.334	-104.51
2.4 GHz	0.879	-178.10	5.18	61.51	0.030	-15.55	0.338	-106.63
2.5 GHz	0.879	-179.98	4.97	59.43	0.030	-17.02	0.342	-108.71
2.6 GHz	0.879	178.20	4.77	57.38	0.029	-18.44	0.346	-110.77
2.7 GHz	0.879	176.44	4.59	55.37	0.029	-19.83	0.351	-112.81
2.8 GHz	0.879	174.74	4.42	53.39	0.029	-21.18	0.355	-114.82
2.9 GHz	0.879	173.09	4.26	51.43	0.029	-22.48	0.360	-116.80
3.0 GHz	0.880	171.49	4.11	49.50	0.028	-23.76	0.366	-118.76
3.2 GHz	0.880	168.39	3.84	45.70	0.028	-26.20	0.376	-122.63
3.4 GHz	0.881	165.43	3.60	41.97	0.027	-28.51	0.387	-126.41
3.6 GHz	0.882	162.57	3.38	38.31	0.026	-30.70	0.399	-130.13
3.8 GHz	0.883	159.81	3.19	34.71	0.025	-32.75	0.410	-133.78
4.0 GHz	0.884	157.13	3.01	31.16	0.025	-34.68	0.422	-137.38
4.2 GHz	0.885	154.52	2.85	27.65	0.024	-36.47	0.433	-140.91
4.4 GHz	0.887	151.96	2.71	24.19	0.023	-38.12	0.445	-144.40
4.6 GHz	0.888	149.45	2.57	20.77	0.022	-39.63	0.457	-147.84
4.8 GHz	0.889	146.98	2.45	17.38	0.022	-40.97	0.468	-151.24
5.0 GHz	0.890	144.55	2.33	14.03	0.021	-42.15	0.480	-154.60
5.2 GHz	0.892	142.15	2.23	10.71	0.020	-43.15	0.491	-157.92
5.4 GHz	0.893	139.78	2.13	7.41	0.019	-43.95	0.503	-161.20
5.6 GHz	0.894	137.43	2.04	4.15	0.018	-44.53	0.514	-164.45
5.8 GHz	0.896	135.11	1.95	0.91	0.018	-44.89	0.525	-167.66
6.0 GHz	0.897	132.80	1.87	-2.30	0.017	-45.00	0.535	-170.85

To download the s-parameters in s2p format, go to the [CGH40006S Product Page](#) and click on the documentation tab.
 Note 2. On a 20 mil thick PCB.

Product Dimensions CGH40006S (Package Type – 440203)

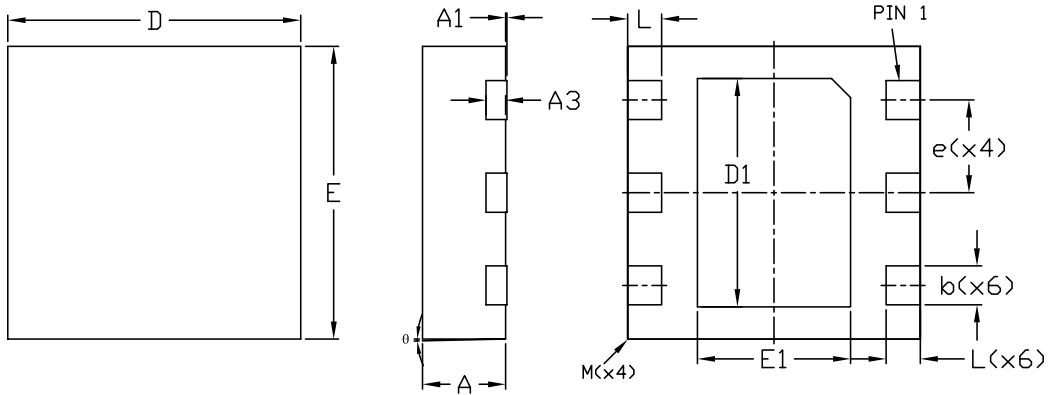

DIM	MILLIMETERS			INCHES		
	MIN	NOM	MAX	MIN	NOM	MAX
A	0.80	0.90	1.00	0.032	0.035	0.039
A1	0	0.02	0.05	0	0.0008	0.002
A3	—	0.20REF.	—	—	0.008REF.	—
b	0.30	0.40	0.45	0.012	0.016	0.018
D	2.85	3.00	3.15	0.112	0.118	0.124
D1	—	2.34BSC	—	—	0.092BSC	—
E	2.85	3.00	3.15	0.112	0.118	0.124
E1	—	1.57BSC	—	—	0.062BSC	—
e	—	0.95BSC	—	—	0.037BSC	—
L	0.20	0.30	0.45	0.008	0.012	0.018
ø	0	—	12	0	—	12
M	—	—	0.05	—	—	0.002

Pin	Input/Output
1	GND
2	RF IN
3	GND
4	GND
5	RF OUT
6	GND

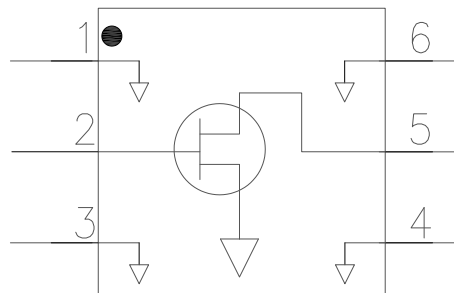

Tape & Reel Dimensions

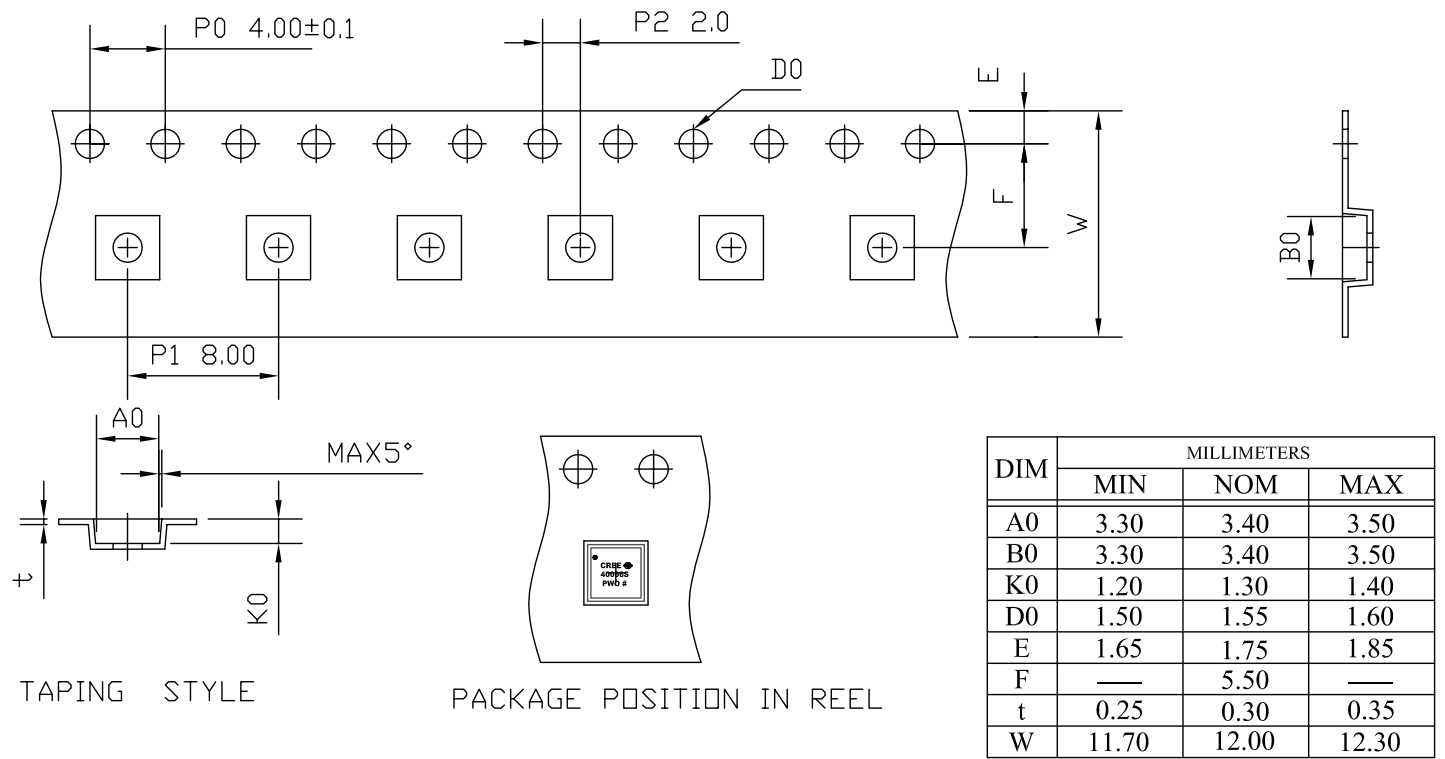

TAPING STYLE

PACKAGE POSITION IN REEL

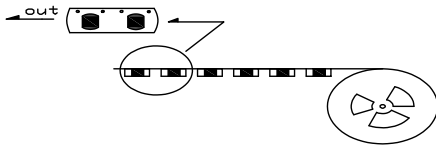

LEADER OF 400 MM AND TRAILER OF 160 MM
OF UNPOPULATED POCKET/REEL

Product Ordering Information

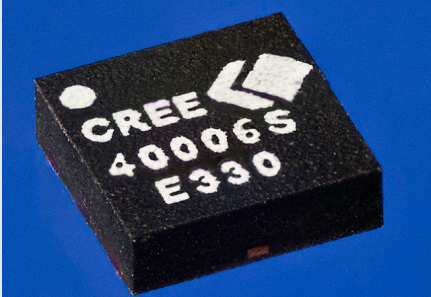
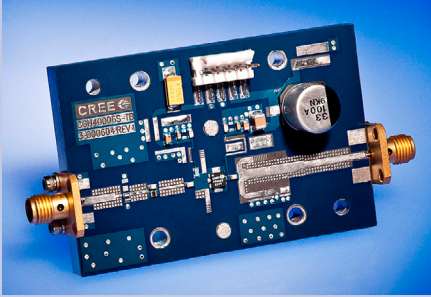
Order Number	Description	Unit of Measure	
CGH40006S	GaN HEMT	Each	
CGH40006S-AMP1	Test board with GaN HEMT installed	Each	
CGH40006S-TR	Delivered in Tape and Reel	250 parts / reel	



Disclaimer

Specifications are subject to change without notice. Cree, Inc. believes the information contained within this data sheet to be accurate and reliable. However, no responsibility is assumed by Cree for any infringement of patents or other rights of third parties which may result from its use. No license is granted by implication or otherwise under any patent or patent rights of Cree. Cree makes no warranty, representation or guarantee regarding the suitability of its products for any particular purpose. "Typical" parameters are the average values expected by Cree in large quantities and are provided for information purposes only. These values can and do vary in different applications and actual performance can vary over time. All operating parameters should be validated by customer's technical experts for each application. Cree products are not designed, intended or authorized for use as components in applications intended for surgical implant into the body or to support or sustain life, in applications in which the failure of the Cree product could result in personal injury or death or in applications for planning, construction, maintenance or direct operation of a nuclear facility.

For more information, please contact:

Cree, Inc.
4600 Silicon Drive
Durham, North Carolina, USA 27703
www.cree.com/RF

Sarah Miller
Marketing & Export
Cree, RF Components
1.919.407.5302

Ryan Baker
Marketing
Cree, Wireless Devices
1.919.407.7816

Tom Dekker
Sales Director
Cree, Wireless Devices
1.919.407.5639